



产品图片	Features 产品特性	Application 应用
 <p>SOP4</p>	<ul style="list-style-type: none"> <li>●Contact Form 触点形式 1b</li> <li>●Load Voltage 输出电压 400V</li> <li>●Load Current 输出电流 0.1A</li> <li>●Low Off-State Leakage Current 漏电流 10μA</li> </ul>	<ul style="list-style-type: none"> <li>●Automatic Test Equipment 自动检测设备</li> <li>●Telephone Equipment 通信设备</li> <li>●Sensing Equipment 传感设备</li> <li>●Security Equipment 安全设备</li> <li>●I/O Modules I/O 模块</li> <li>●Modem 调制解调器</li> </ul>

## Type 种类

Output rating 输出额定		Marking model 标 刻型号	Part No. 订货型号
Load voltage 负载电压	Load current 负 载电流		
400V	0.1A	BCY414S	BCY414S

## Dimensions 外形尺寸

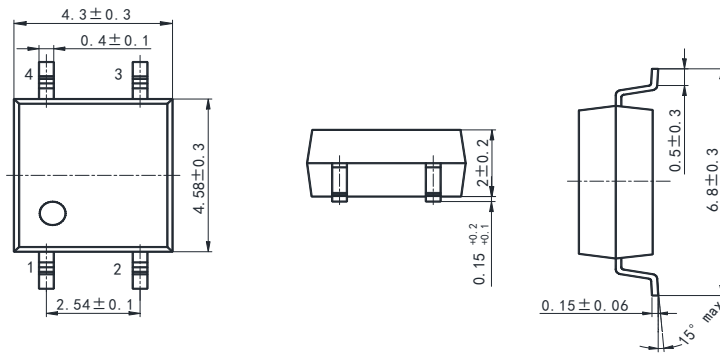

## Terminal Identification 引脚标识

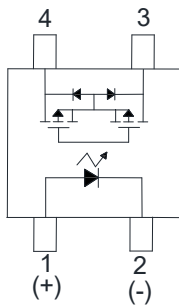

## Wiring Diagram 接线图

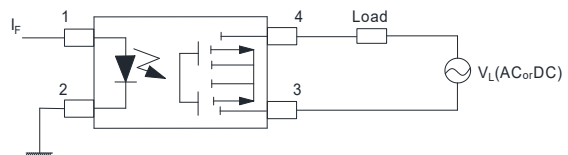



## Technical parameters 技术参数 (Ambient Temperature 25°C)

I/O Absolute Maximum Ratings 输入输出电气参数最大值

Item 项目	Symbol 符号	BCY414S		
Operating Temperature 工作温度	$T_{OPR}$	-40°C~+85°C		
Storage Temperature 储存温度	$T_{STG}$	-40°C~+100°C		
Input 输入	Continuous LED Current 工作电流	MAX. 最大值	$I_F$	50mA
	Peak LED Current LED 峰值电流 (f=100Hz, Duty=1%)	MAX. 最大值	$I_{FP}$	1000mA
	LED Reverse Voltage 反向电压	MAX. 最大值	$V_R$	5V
	Input Power Dissipation 输入功耗	MAX. 最大值	$P_{IN}$	75mW
Output 输出	Load Voltage 输出电压	MAX. 最大值	$V_L$	400V (AC peak or DC)
	Load Current 输出电流	MAX. 最大值	$I_L$	0.1A
	Peak Load Current 峰值输出电流 (100ms, 1shot)	MAX. 最大值	$I_{PEAK}$	0.3A
	Output Power Dissipation 输出功耗	MAX. 最大值	$P_{OUT}$	500mW
Total Power Dissipation 总功耗	MAX. 最大值	$P_T$	550mW	
I/O Breakdown Voltage 输入输出间隔离电压	MAX. 最大值	$V_{I/O}$	1500Vrms	
I/O Breakdown Voltage 输入输出间隔离电压 (加注 H)	MAX. 最大值	$V_{I/O}$	3750Vrms	

Electrical Specifications 输入输出电气参数

Item 项目	Symbol 符号	BCY414S	Conditions 条件		
Input 输入	LED Forward Voltage 正向电压	TYP. 典型值	$V_F$	1.2V	$I_F=10mA$
		MAX. 最大值		1.4V	
	Operation LED Current 接通电流	TYP. 典型值	$I_{F ON}$	0.5mA	
		MAX. 最大值		3mA	
Recovery LED Voltage 关断电压	MIN. 最小值	$V_{F OFF}$	0.5V		
Output 输出	On-Resistance 导通电阻	TYP. 典型值	$R_{ON}$	20Ω	$I_F=0mA, I_L=100mA,$ within 1 sec.
		MAX. 最大值		50Ω	
	Off-State Leakage Current 漏电流	MAX. 最大值	$I_{LEAK}$	10μA	$I_F=5mA, V_L=Rating$
Output Capacitance 输出端容量	TYP. 典型值	$C_{OUT}$	165pF	$I_F=5mA, V_L=0V,$ f=1MHz	
Time parameters 时间参数	Turn-On Time 接通时间	TYP. 典型值	$T_{ON}$	0.02ms	$I_F=5mA, I_L=50mA$
		MAX. 最大值		1ms	
	Turn-Off Time 关断时间	TYP. 典型值	$T_{OFF}$	0.5ms	
		MAX. 最大值		3ms	
I/O 输入输出	I/O Insulation Resistance 绝缘电阻	MIN. 最小值	$R_{I/O}$	1000MΩ	DC500V
	I/O Capacitance 隔离电容	TYP. 典型值	$C_{I/O}$	0.8pF	f=1MHz

通讯地址: 陕西省西安市国家民用航天产业基地航天中路385号众创广场11层1101.1102.1104室

生产地址: 陕西省宝鸡市陈仓区群力路1号 邮政编码: 721300

电话: (0917)-6293969 18609177833

传 真: (0917)-6293969



## Reference Data 参考数值 (BCY414S)

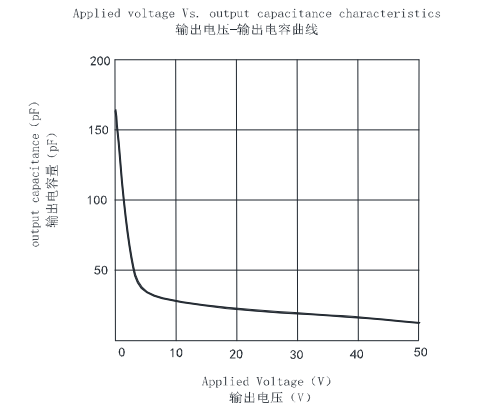
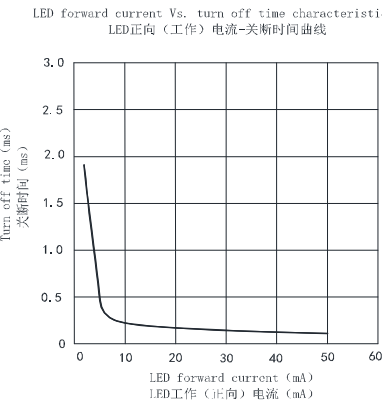
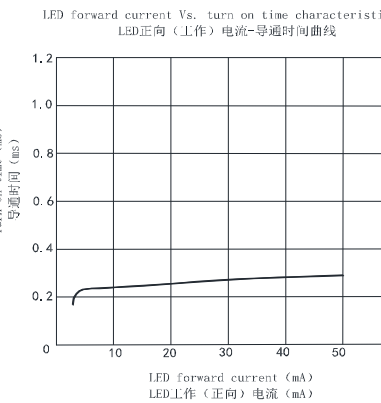
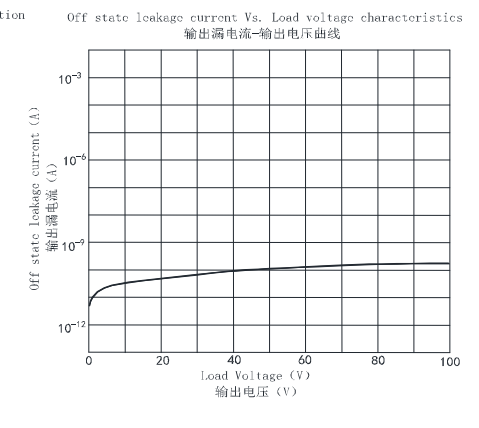
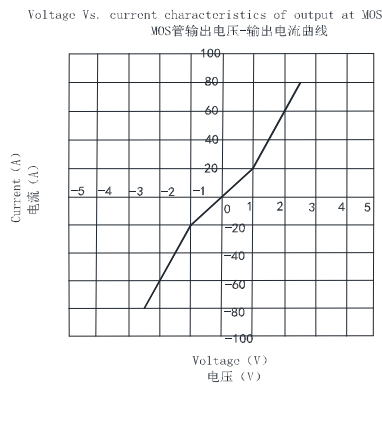
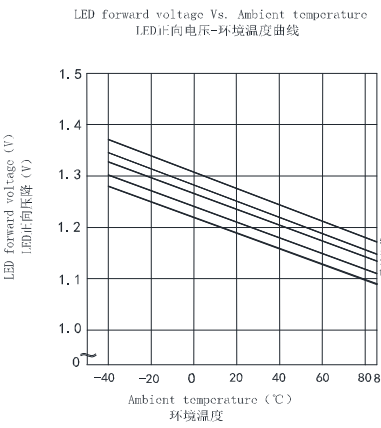
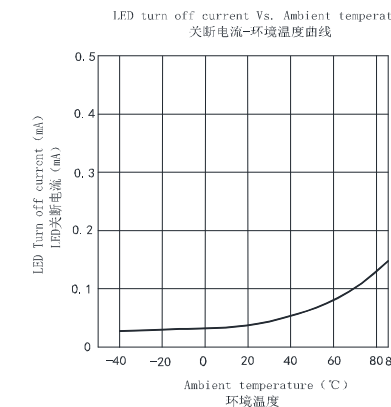
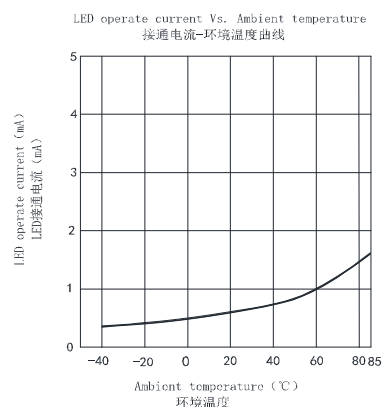
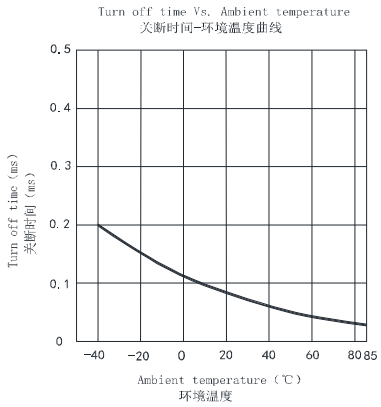
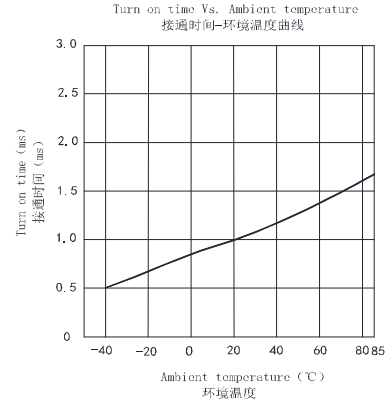
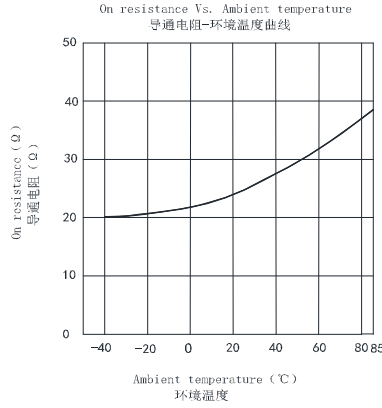
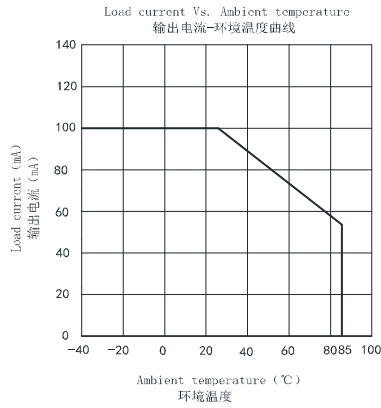

通讯地址: 陕西省西安市国家民用航天产业基地航天中路385号众创广场11层1101.1102.1104室

生产地址: 陕西省宝鸡市陈仓区群力路1号 邮政编码: 721300

电话: (0917)-6293969 18609177833

传 真: (0917)-6293969